



VS BN series

— Solar Charge Controller

User Manual



Models:

VS1024BN/VS2024BN

VS3024BN/VS6024BN

VS4548BN/VS6048BN

Contents

1 Important Safety Information	1
2 General Information.....	2
2.1 Product Overview	2
2.2 Product Features.....	4
2.3 Optional Accessories	6
3 Installation Instructions.....	8
3.1 Mounting	8
3.2 Wiring.....	10
4 Operation.....	13
4.1 PWM Technology	13
4.2 Battery Charging Information.....	13
4.3 HMI Interface	16
4.4 Operation and Displaying of Controller	18
5 Protection, Troubleshooting and Maintenance.....	45
5.1 Protection.....	45
5.2 Troubleshooting	46
5.3 Maintenance.....	49
6 Technical Specifications	50

1 Important Safety Information

Save These Instructions

This manual contains important safety, installation and operating instructions.

The following symbols are used throughout this manual to indicate potentially dangerous conditions or mark important safety instruction.



WARNING: Indicates a potentially dangerous condition.

Use extreme caution when performing this task.



CAUTION: Indicates a critical procedure for safe and proper operation of the controller.



NOTE: Indicates a procedure or function that is important for safe and proper operation of the controller.

General Safety Information

- Read all of the instructions and cautions in the manual before installation.
- There are no user serviceable parts inside the controller. Do not disassemble or attempt to repair it.
- Mount the controller indoors. Prevent exposure to the elements and do not allow water to enter the controller.
- Install VS BN controller in well ventilated places, the VS BN controller heatsink may become very hot during operation.
- Install external fuses/breakers as required.
- Disconnect the solar module, load and fuse/breakers near to battery before installing or adjusting the controller.
- Power connections must remain tight to avoid excessive heating from a loose connection.

2 General Information

Thank you for selecting VS BN series solar charge controller. The controller adopts advanced digital control technology, LCD display and automatically operation. With the features of Pulse Width Modulation (PWM) battery charging and unique control technology, the controller will improve the long battery life efficiently. Our controller has many unique features and easy to use.

2.1 Product Overview

The controller could charge battery and discharge automatically for off-grid photovoltaic (PV) systems. The charging process has been optimized for long battery life and improved system performance. The comprehensive self-diagnostics and extensive electronic protection can prevent damage against incorrect wiring or system faults. Features:

- 32 bit MCU with high speed and high performance
- 12 bit A/D high-precision sampling to ensure accuracy
- Excellent EMC design
- Nominal system voltage automatic recognition or user-defined working voltage
- High efficient Series mode PWM charging, increase the battery lifetime and improve the solar system performance
- Use MOSFET as electronic switch, without any mechanical switch
- Wide feasibility and, recognize day or night automatically
- Graphical dot-matrix LCD and 4 buttons combinations as HMI (human-machine interface) for full menu and easy operation
- Humanized design of browser interface to facilitate the operations
- All of control parameters could be set and modified
- Several load control methods are supported to convenient for different demand
- Support 4 charging preprogram options: Sealed, Gel, Flooded and User-defined
- Adopt temperature compensation and update charging and discharging parameters automatically to improve the battery lifetime
- With the feature of input filter, the voltage spike could be restrained effectively

- Actual Power Display and record function make convenience to check the datum every day, every month and every year
- RS-485 ports via the open standard Modbus protocol are supported for long-distance communication and communication compatibility
- Standard RJ45 interface is used to connect to remote display unit (MT50) or PC software to monitor the actual data or modify parameters
- New SOC method could calculate the battery capacity accurately
- Electronic protection: Overheating, over discharging, overload, and short circuit
- Reverse protection: any combination of solar module and battery

2.2 Product Feature



VS1024BN / VS2024BN

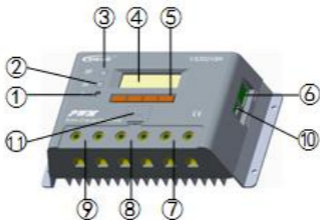

VS3024BN / VS4548BN / VS60**BN

1 – Local temperature sensor

It is used to acquire ambient temperature to do temperature compensation for charging and discharging.

2 – Fault LED indicator

An LED indicator that shows system faults

3 – Charging LED indicator

An LED indicator that shows charging status

4 – Liquid crystal display (LCD)

Monitoring interface for solar system parameters and running status

5 –Buttons

4 buttons used to operate and configure controller

6 – Communication port

Connect remote display unit MT50(Optional Accessories) or PC software

7 – Load terminals

Connect loads.

8 – Battery terminals

Connect batteries.

9 – Solar module terminals

Connect solar modules





10 – Remote temperature sensor interface(optional)



Connect remote temperature sensor (Optional Accessories) to acquire ambient temperature

11 – Battery slot

Mount cell battery(RTC), battery model is CR1220-3.3V.

2.3 Optional Accessories

<p>Remote Temperature Sensor (RTS300R47K3.81A)</p>		<p>Acquisition of battery temperature for undertaking temperature compensation of control parameters, the standard length of the cable is 3m (length can be customized). The RTS300R47K3.81A connects to the port (8th) on the controller. NOTE: The temperature sensor short-circuited or damaged, the controller will be charging or discharging at the default temperature 25 °C.</p>
<p>USB to RS485 cable CC-USB-RS485-150U</p>		<p>USB to RS485 converter is used to monitor each controller using Solar Station PC software. The length of cable is 1.5m. TheCC-USB-RS485-150U connects to the RS485 Port on the controller.</p>
<p>RS485 to RS485 cable CC-RS485-RS485-200U</p>		<p>RS485 to RS485 converter is used to connect the accessories SPP-02,MT50,eBox-WIFI-01,eBox-BLE-01,the standard length of the cable is 3m (length can be customized).</p>
<p>Super Parameter Programmer SPP-02</p>		<p>SPP-02 can realize one-key setting parameter operation.</p>
<p>Remote Meter MT50</p>		<p>MT50 can display various operating data and fault info the system. The information can be displayed on a backlit LCD screen, the buttons are easy-to-operate, and the numeric display is readable.</p>

WiFi Serial Adapter eBox-WIFI-01		After the controller is connected with the eBox-WIFI-01 through the standard Ethernet cable (parallel cable), the operating status and related parameters of the controller can be monitored by the mobile APP software through WIFI signals.
RS485 to Bluetooth Adapter eBox-BLE-01		After the controller is connected with the eBox-BLE-01 through the standard Ethernet cable (parallel cable), the operating status and related parameters of the controller can be monitored by the mobile APP software through Bluetooth signals.
<p>NOTE: For setting and operation of accessory, please refer to accessory's user manual.</p>		

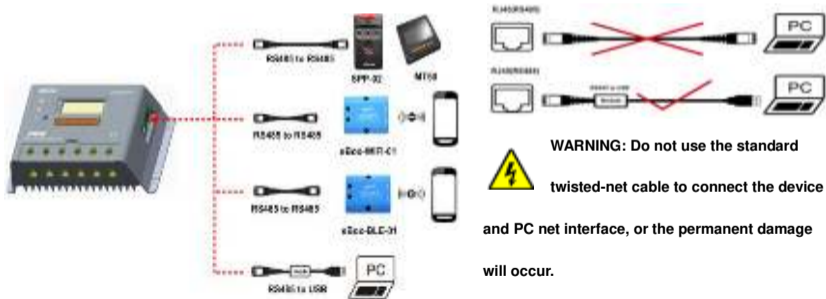

3 Installation Instructions

3.1 Mounting

- Read through the entire installation section first before beginning installation.
- Be very careful when working with batteries. Wear eye protection. Have fresh water available to wash and clean any contact with battery acid.
- Use insulated tools and avoid placing metal objects near the batteries.
- Explosive battery gasses may be present during charging. So well ventilation of battery box is recommended.
- Avoid direct sunlight and do not install in locations where water can enter the controller.
- Loose power connections and/or corroded wires may result in resistive connections that melt wire insulation, burn surrounding materials, or even cause fire. Ensure tight connections and use cable clamps to secure cables and prevent them from swaying in mobile applications.
- Gel, Sealed or Flooded batteries are recommended, other kinds please refer to the battery manufacturer.
- Battery connection may be wired to one battery or a bank of batteries. The following instructions refer to a singular battery, but it is implied that the battery connection can be made to either one battery or a group of batteries in a battery bank.
- Select the system cables according to $3.5A/mm^2$ current density.



CAUTION: The VS BN controller requires at least 150mm of clearance above and below for proper air flow. Ventilation is highly recommended if mounted in an enclosure.



WARNING: Risk of explosion! Never install the controller in a sealed enclosure with flooded batteries! Do not install in a confined area where battery gassed can accumulate.

Step 1: Choose Mounting Location

Locate the controller on a vertical surface protected from direct sun, high temperature, and water. And make sure good ventilation.

Step 2: Check for clearance

Place the controller in the location where it will be mounted. Verify sufficient room to run wires and sufficient room above and below the controller for air flow.

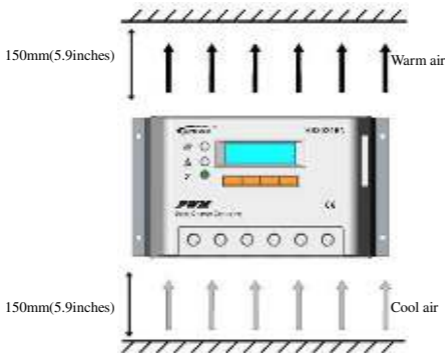

Step 3: Mark Holes

Mark the four (4) mounting hole locations on the mounting surface.

Step 4: Drill Holes

Remove the controller and drill 4mm holes in the marked locations.

Step 5: Secure Controller

Place the controller and align the mounting holes with the drilled holes in step 4. Secure the controller in place using the mounting screws.

3.2 Wiring



NOTE: A recommended connection order has been provided for maximum safety during installation.



NOTE: the controller is common negative one.



CAUTION: Don't connect the loads with surge power exceeding the ratings.



CAUTION: Secure all wiring for mobile applications. Use cable clamps to prevent cables from swaying. Unsecured cables create loose and resistive connections which may lead to excessive heating and/or fire.



WARNING: Risk of explosion or fire! Never short circuit battery positive (+) and negative (-) or cables.



WARNING: Risk of electric shock! Exercise caution when handling solar wiring. The solar module(s) high voltage output can cause severe shock or injury. Be careful operation when installing solar wiring.

If nominal system voltage is 12V, make sure battery voltage is higher than 9V before starting the controller. If nominal system voltage is 24V, make sure voltage of battery is no less than 18V; if nominal system voltage is 36V, make sure voltage of battery is no less than 30V; if nominal system voltage is 48V, make sure voltage of battery is no less than 42V. The nominal system voltage can only be identified when controller is powered

on automatically.

Controller's load terminals can be connected to DC electric equipments whose nominal operation voltage is the same as nominal voltage of battery. The controller supplies power to loads with battery voltage.

It is suggested that positive pole or negative pole of battery and loads be connected to a safety device whose operation current is not twice lower than nominal charging or discharging current. Do not switch on the safety device while it is being installed. Switch on the safety device after the wiring is confirmed.



CAUTION: On occasions that controller must be connected to the ground. For common positive controller, the positive pole must be connected to the ground, on the contrary, the negative pole must be connected to the ground for common negative controller.

*** Wire conductor length:**

VS1024BN ; 7mm

VS2024BN ; 13mm

VS3024BN ; 10mm

VS4548BN / VS60BN ; 14mm**

Step 1: Wiring and switching on

After solar system is wired, check all wirings carefully to make it clear whether all 6 terminals are connected correctly and tightened. According to the order of switching on in the chart, battery first, loads second and solar module third successively to avoid nominal system voltage identification error.

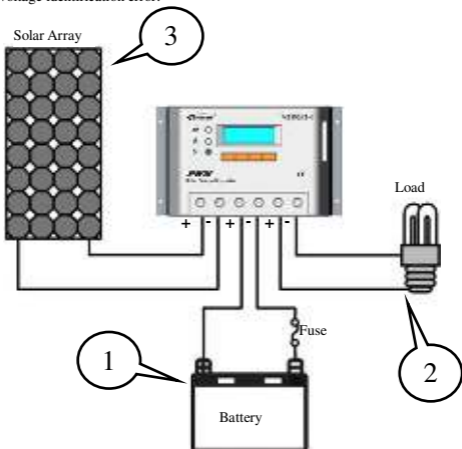

Step 2: Power on

When controller starts up, liquid crystal display (LCD) displays initialization interface and 2 indicator LED will be blinked once. Check if it is correct. If there are no above procedures, refer to section 5 for troubleshooting.

4 Operation

4.1 PWM Technology (Series Pulse Width Modulation)

The controller adopts the advanced series pulse width modulation (PWM) charging mode. With range of 0-100%, it can charge the battery quickly and stably under any condition of solar photovoltaic system.

PWM charging mode use automatic conversion duty ratio pulses current to charge the battery. The battery can be fully charged safety and rapidly with the pulse current.

Intermissions make oxygen and hydrogen generated by chemical reaction combined again and absorbed. It can eliminate concentration polarization and ohm polarization naturally and reduce the internal pressure of the battery so that the battery can absorb more power.

Pulse current charging mode makes battery have more time to react which reduces the gassing volume and makes battery improve the acceptance rate of charging current.

4.2 Battery Charging Information

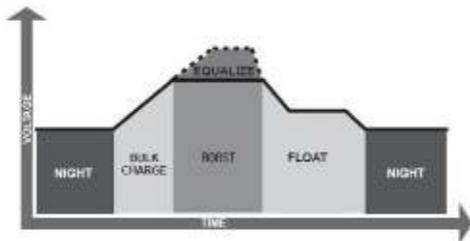

•Bulk Charge

In this stage, the battery voltage has not yet reached boost voltage and 100% of available solar power is used to charge the battery.

•Boost Charge

When the battery has recharged to the Boost voltage setpoint, constant- current regulation

is used to prevent heating and excessive battery gassing. The Boost stage remains 120 minutes and then goes to Float Charge. Every time when the controller is powered on, if it detects neither over discharged nor overvoltage, the charging will enter into boost charging stage.

•Float Charge

After the battery is fully charged in Boost voltage stage, the controller reduces the battery voltage to Float voltage set point. When the battery is fully recharged, there will be no more chemical reactions and all the charge current transmits into heat and gas at this time. Then the controller reduces the voltage to the floating stage, charging with a smaller voltage and current. It will reduce the temperature of battery and prevent the gassing, also charging the battery slightly at the same time. The purpose of Float stage is to offset the power consumption caused by self consumption and small loads in the whole system, while maintaining full battery storage capacity.

In Float stage, loads can continue to draw power from the battery. In the event that the system load(s) exceed the solar charge current, the controller will no longer be able to maintain the battery at the Float setpoint. Should the battery voltage remains below the boost reconnect charging voltage, the controller will exit Float stage and return to Bulk charge.

•

Equalize Charge



WARNING: Risk of explosion!

Equalizing flooded battery can produce explosive gases, so well ventilation of battery box is necessary.



NOTE: Equipment damage!

Equalization may increase battery voltage to the level damaging to sensitive DC loads. Ensure that all load allowable input voltages are greater than the equalizing charging set point voltage.



NOTE: Equipment damage! Over-charging and excessive gas precipitation may damage the battery plates and activate material shedding on them. Too high an equalizing charge or for too long may cause damage. Please carefully review the specific requirements of the battery used in the system.

Certain types of batteries benefit from periodic equalizing charge, which can stir the electrolyte, balance battery voltage and complete chemical reaction. Equalizing charge increases the battery voltage higher than the standard complement voltage which gasifies the battery electrolyte.

Every month 28th solar controller will engender equalize charging stage. It will remain 120mins when equalize stage is constant, or it will remain 180mins when equalize charging accomplishes off and on. Equalize charge and boost charge are not carried out constantly in a full charge process to avoid too much gas precipitation or overheating of battery.

4.3 HMI Interface

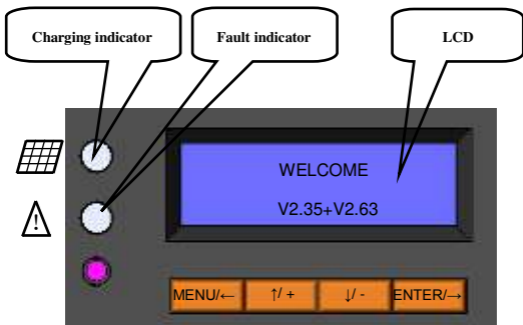

■ Buttons instruction:



Cursor down / Number reduce button



Cursor up / Number add button



Menu / Cursor left button



Enter / cursor right button

● Charging indicator

GREEN ON whenever sunlight is available for battery charging and the charging system is normal.

Charging LED indicator

Table 4-1

Color	Indicator	Charging Status
Green	Steady On	Charging

● Fault indicator

When the following cases occur, fault indicator red flashing:

Solar module: Over current, Measure error of voltage, Short of reverse-protection MOS-I, Short of charging MOS-C, MOS-I or MOS-C disconnection or MOS break in control section;

Battery: Over voltage, Measure error of voltage, Over temp;

Load: Over load, Short, Short of discharging MOS, Measure error of voltage;

Device: Over temperature.

For trouble shooting, refer to chapter 5.

Fault LED indicator

Table 4-2

Color	Indicator	Charging Status
Red	Flashing	PV: Measure Err、MOS-I Short、MOS-C Short、MOS Break
		BATT: OVD、Error、Over Temp
		LOAD: Overload、Short、MOS Short、Error
		DEVICE: Over Temp

4.4 Operation and Displaying

• Load mode

1. Manual mode(default)

This mode is to turn ON and OFF the load by press  button.

Parameter	Detail	Note
Manual ON(default)	The load will open automatically after the controller is initialized. If the battery power is enough and the controller works well, load will keep open	Press ENTER button to control load at the standby interface in the controller or in the MT50/100;
Manual OFF	The load will keep off after the controller is initialized. Only when open load manually, load can be output. If the battery power is enough and the controller works well, load will keep open	The load also could be got through or shut down by monitor software in remote PC;

2. Light On/Off

When solar module voltage goes below the point of NTTV (Night Time Threshold Voltage) at sunset, the controller will recognize the starting voltage and turn on the load after pre-set time delay when the battery power is enough and the controller works well.

When solar module voltage goes above the point of DTTV (Day Time Threshold Voltage), the solar controller will recognize the starting voltage and turn off the load after pre-set time delay. The pre-set time delay is range of 0 to 99 minutes.

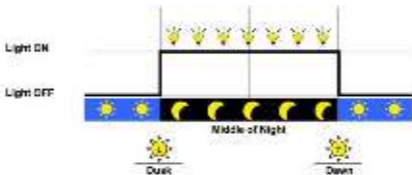

3. Light ON + Timer

When solar module voltage goes below the point of NTVV (Night Time Threshold Voltage) at sunset; the solar controller will recognize the starting voltage and turn on the load after pre-set delay time. Working time 2 is the open time of load in the light mode before dawn. The load will be on for several hours which users set. If the work time are changed during the process, the controller will not reset the counter.

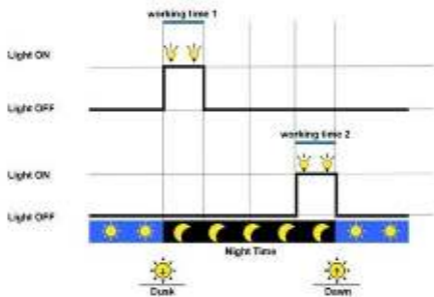

Parameter	Detail	Note
Working Time 1	The open time of load in the light mode after dusk	The value is set to ZERO means the controller will not work at this working time period; the actual time of load-on is relative with night time, working time1 and working time2
Working Time 2	The open time of load in the light mode before dawn	
Night time	The controller calculated the total length of the night by self-learning. The time should be more than 3 hours	

4. Timer

The mode includes single and double time intervals. Set the starting and ending time for each time interval and controller works according to the set time interval.

Parameter	Detail
Time Control 1	Set the begin and end time 1 of the load output
Time Control 2	Set the begin and end time 2of the load output
Single	The load output according to time1
Double	The load output according to time1 and time2

● Device Parameters

Parameter	Detail
ID	Range: 1 - 200
Clock	Format:dd-mm-yyyy hh-mm-ss
Password	Default: 000000

- **Battery Charging Setting**

Battery Type	Note
Sealed (default)	Constant value
GEL	Constant value
Flooded	Constant value
User	Defined by user

• Operation and displaying of controller

➤ Initialization Interface

When controller is powered on, the following picture will be painted during the initialization:

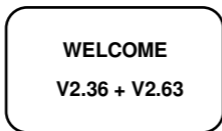

➤ Main Menu Interface

After controller is initialized, the monitoring interface will update automatically. Press button **MENU/←** to main menu 1 interface which displays the following contents:

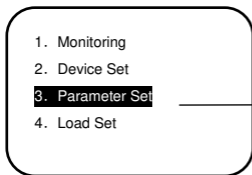



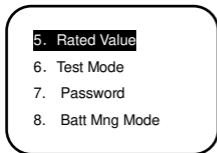

Inverse cursor showing the contents can be operated

Press **↓/ -** button to enter into main menu 2 and main menu 3 interface which displays the following contents:



➤ System Monitor Interface

In the main menu interface, press  or , the inverse cursor moves between main menu 1 and main menu 2. When the inverse cursor points at **1. Monitoring** in the main menu 1, press  to enter into the system monitoring interface which displays contents as below. Press  or  display every real-time parameters interface circularly.

▼ Solar array voltage and current

The interface shows real-time voltage and current of solar module.

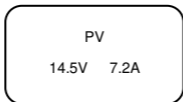

▼ Battery voltage and current

Press  to enter into the following interface which shows actual battery voltage and current. Minus sign with current means that the battery is in discharging status. Positive sign means the battery is in charging.



▼ Battery temperature and battery SOC

Press  to enter into the following interface which indicates actual temperature and SOC of battery.

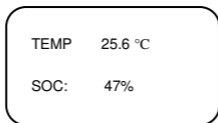

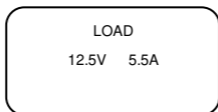

▼ Load voltage and current

Press  and enter into the following interface which indicates actual voltage and current of loads.



▼ Real-time clock and imaging system status

Press  and enter into the following interface which indicates real-time clock and graphic system status. If choose the manual mode with loads, press  in the interface to control loads on and off alternatively.



■ Introductions to system status icons:

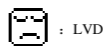
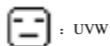
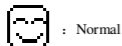
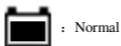

* Icons indicating battery charging are dynamic effects.

▼ System status

Press  and enter into the following interface which indicates system status.

PV : Disconnect
BATT : NoCharge / Normal
LOAD : On
DEVICE : Normal

PV status:

Connect

Disconnect

Measure Err

MOS-I Short

MOS-C Short

MOS Break

BATT charging status:

Equalize

Boost

Float

No Charge

BATT status:

LVD

UVW

Normal

OVD

Error

OverTemp

LOAD status:

On

Off

OverLoad

Short

Error

MOS Short

DEVICE status:

Normal

OverTemp

* When fault with inverse cursor above exists for 2 minutes along without any operation, it will jump into that page automatically.

▼ Charging energy statistics

Char. Energy

Day: 1.17KWh



Mon: 25.35KWh

Total: 98.74KWh

▼ Discharging energy statistics

Disch. Energy	
Day:	0.75KWh
Mon:	18.53KWh
Total:	54.32KWh





Device Setting

In the main menu, press  or  button to make the inverse cursor point to **2. Device Set**, press  to enter device setting interface which displays the following contents. When setting in this interface, real time clock will stop running. Please correct real time clock again after parameters are changed.

Device Set
Date : 12 - 05 - 2011
Time : 12 : 24 : 23

Device Set
ID: 001
Backlight: 010 sec

Device Set
TempUnit:
Cel Fah

In the interface, press  or , the inverse cursor moves among every parameter. Pressing  button could move the inverse cursor back to main menu. When inverse cursor points at the parameter, the contents of the parameter can be modified. press  to increase the value and press  to decrease the value. LCD backlight auto-off time can be set between 00 ~999 seconds.

The below message box will be prompted after press **ENTER/→** . Press **↑/+** or **↓/-** to choose save or cancel operation. When modification canceled, the interface will go back main menu.. Auto-off time of LCD backlight is 60 seconds as default.

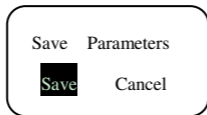

If save confirmation is chosen, the system will automatically check the validity of parameters. If the check is passed, the promptation of successful saving will occur below. After parameters successfully saved, it returns to main menu interface.

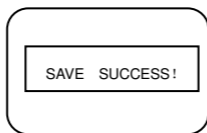

Press and hold both **↑/+** and **↓/-** button for 3 seconds to enter factory mode in the main interface. The clear operation can't be recalled, so take care!

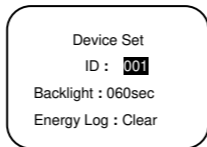

➤ Charging and Discharging Parameters Setting Interface

press **ENTER/→** to enter into charging and discharging parameters setting interface as inverse cursor at 3. Parameter Set in main menu 1. press **MENU/←**, it moves back to the previous interface and the inverse cursor points to the position of the first parameter. The following control voltage parameters value must be between 9v and 17v and in strictly accordance with: High Volt Disconnect > Charging limit voltage \geq Equalization voltage \geq Boost voltage \geq Float voltage > Boost return voltage; High Volt Disconnect > Over Voltage Reconnect; Low voltage reconnect > Low voltage disconnect \geq Charging limit voltage; Under voltage recover > Under voltage warning \geq Charging limit voltage; Boost return voltage > Low voltage reconnect.

▼ Temperature compensation coefficient

Press **MENU/←** or **ENTER/→**, then the inverse cursor moves among every parameters sequentially. Press **↑/+** or **↓/-** to modify temperature compensation coefficient.

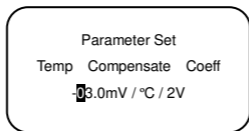

▼ Control parameters interface 1

Press **ENTER/→** continuously and the inverse cursor will move to the control parameters interface. Press **↑/+** or **↓/-** to modify the following control parameters. The value in this interface could be modified only when the battery type is USER defined.

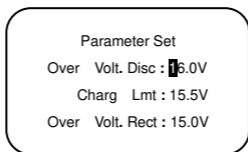

▼ Control parameters interface 2

Press **ENTER/→** continuously and the inverse cursor will move to the control parameters interface. Press **↑ / +** or **↓ / -** to modify the following control parameters. The value in this interface could be modified only when the battery type is USER defined.

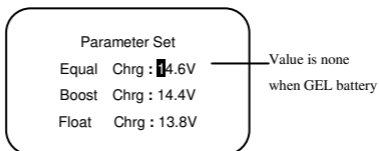

▼ Control parameters interface 3

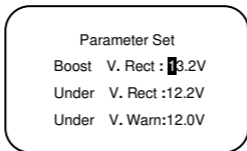

Press **ENTER/→** continuously and the inverse cursor will move to the control parameters interface. Press **↑ / +** or **↓ / -** to modify the following control parameters. The value in this interface could be modified only when the battery type is USER defined.

▼ Control parameters interface 4

Press **ENTER/→** continuously and the inverse cursor will move to the control parameters interface. Press **↑ / +** or **↓ / -** to modify the following control parameters. The value in this interface could be modified only when the battery type is USER defined.

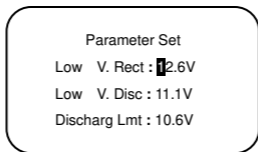

▼ Control parameters interface 5

Press **ENTER/→** continuously and the inverse cursor will move to the control parameters interface. Press **↑/+** or **↓/-** to modify the following control parameters.

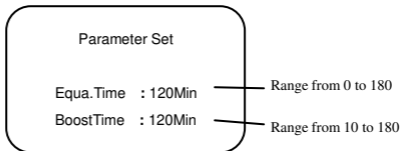

The interface below will prompt only when the SOC is selected in the Batt Mng Mode.

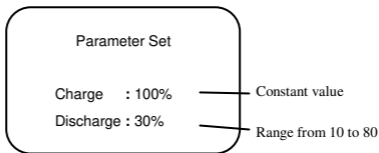

Only when the inverse cursor moves to the last option, the modified parameters could be saved. Press **ENTER/→** and the following picture appears.

Press **↑/+** or **↓/-** to choose save or cancel operation. When modification canceled, the interface will go back main menu.

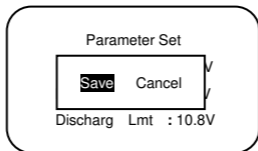

When save operation confirmed, the indication of successful saving will prompt as follows. After parameters successfully saved, it returns to main menu interface.

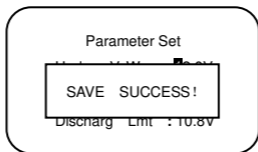

➤ Load Control Interface

When the inverse cursor rests on **4. Load Set** in main menu 1, press **ENTER/→** and enter load control interface with the following contents displayed.

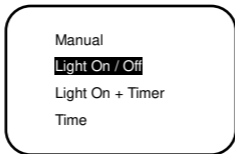



* When set light control threshold voltage, it should meet the requirement , refer to Chapter 6 Threshold Voltage Value.

▼ Manual control interface

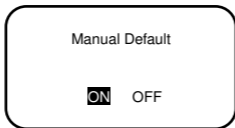
When the inverse cursor rests on **Manual** in main menu 1, press **ENTER/→** and enter manual load control interface with the following contents displayed.



Press  or  to choose ON or OFF as default. After confirmation, press  and the messagebox below will prompt. When it is cancelled, the inverse cursor moves back to the main menu interface.

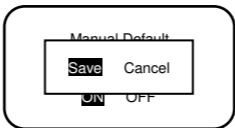

When save confirmation chosen, the indication of successful saving will occur as follows. After parameters successfully saved, it returns to main menu interface.

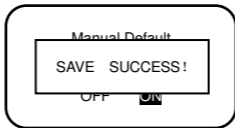

▼ Light control interface

When the inverse cursor is at **Light On / Off**, press  to enter light control interface shown as below:

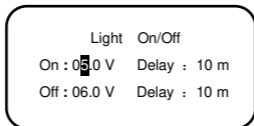

Press **MENU/←** or **ENTER/→**, the inverse cursor moves among each parameters sequentially. Press **↑/+** or **↓/-** to modify the values. The below message box will be prompted after press Enter. Press **↑/+** or **↓/-** to choose save or cancel operation. When modification canceled, the interface will go back main menu.

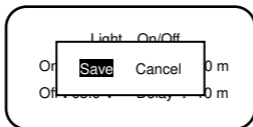

When save operation confirmed, the indication of successful saving will prompt as follows. After parameters successfully saved, it returns to main menu interface.

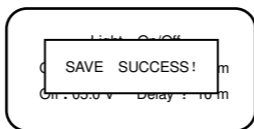

▼ Light control + timer control interface

When the inverse cursor is at **Light On + Timer**, press **ENTER/→** to enter into light control and time control interface.

Light On + Timer
On : 05.0 V Delay : 10 m
Off : 06.0 V Delay : 10 m
Night Time : 10 : 00

Light On + Timer
Period 1: 01:00
Period 2: 01:00

Press **↑/+** or **↓/-** to modify each parameter. The below message box will be prompted after press **ENTER/→**. Press **↑/+** or **↓/-** choose save or cancel operation. When modification canceled, the interface will go back main menu.

Light On + Timer

Save	Cancel
-------------	--------

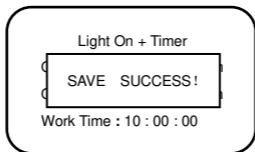

Work Time : 10 : 00 : 00

When save operation confirmed, the indication of successful saving will prompt as follows. After parameters successfully saved, it returns to main menu interface.





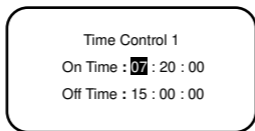

NOTE: When the “OFF” time is later than local sunrise time, the controller will turn off the load output at the sunrise time, because light control’s priority level is higher!

▼ Time control interface

When the inverse cursor rests on **Time** in the time control interface, press  enter into time control interface. Press  or  to modify all parameters of time interval 1.



When  is continuously pressed, it will enter into the following interface. Press  or , the inverse cursor moves among every parameters. Press  or  to modify value of time interval 2. When choosing **Double** time control mode, the load output will accord to time1 and time2.

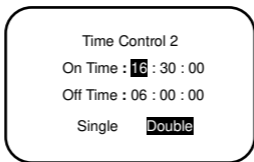

* In the double time control mode, time1 and time2 could not overlap.

When choosing **Single**, only value of time1 can be modified. The interface is as follows:

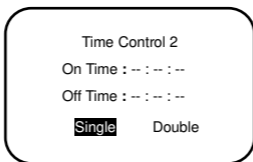

If changing the time, press **ENTER/→** to submit and the following message will prompt:

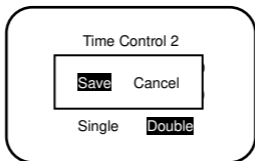



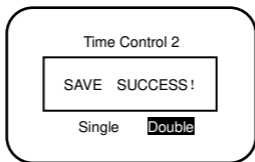

Press **↑ / +** or **↓ / -** to select "save" to confirm update or cancel. After confirmed, the cursor will move back to the main menu.



When updating successfully, the prompt will show below and then move back to the main menu.

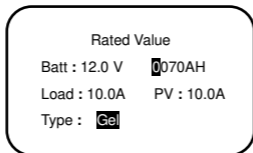

➤ Nominal Parameter Interface

Press  or , move inverse cursor to **5. Rated Value**, then press  button to enter into nominal parameter interface below. Battery rate and capacity can be modified. the batter rate are 12v, 24v, 36v, 48v or auto. Battery capacity ranges from 1 to 9999AH in the interface,. Press  or  to increase or decrease the value.



If changing the value, press  to submit and the following message will prompt: Press  or  to select "save" to confirm update or cancel. After confirmed, the cursor will move back to the main menu.

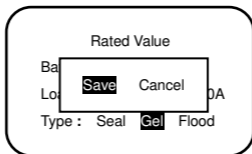

When updating successfully, the prompt will show below and then move back to the main menu.

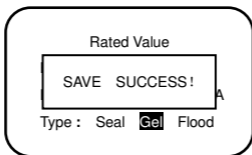

➤ Test Mode Interface

Press **MENU/←** or **ENTER/→**, move inverse cursor to **6. Test Mode**, then press **ENTER/→** and enter into test mode interface below:

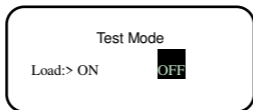

➤ Password Setting Interface

Press **MENU/←** or **ENTER/→**, move inverse cursor to **7. Password**, then press **ENTER/→** and enter into test mode interface below:

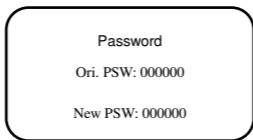

If changing the value, press **ENTER/→** to submit and the following message will prompt: Press **↑/+** or **↓/-** to select “save” to confirm update or cancel. After confirmed, the cursor will move back to the main menu.

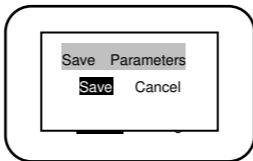

When updating successfully, the prompt will show below and then move back to the main menu.

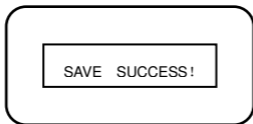

➤ Battery Charge Mode Setting Interface

Press **MENU/←** or **ENTER/→**, move inverse cursor to **8. Batt Mng Mode**, then press **ENTER/→** and enter into test mode interface below:

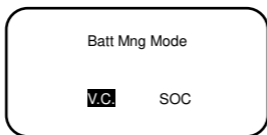

If changing the value, press **ENTER/→** to submit and the following message will prompt: Press **↑/+** or **↓/-** to select “save” to confirm update or cancel. After confirmed, the cursor will move back to the main menu.

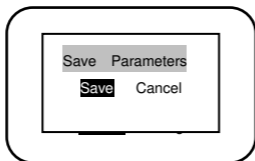

When updating successfully, the prompt will show below and then move back to the main menu.

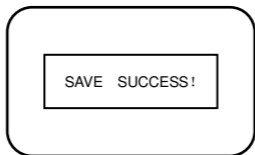

➤ Factory Reset Mode Interface

Press **MENU/←** or **ENTER/→**, move inverse cursor to **0. Factory Reset**, then press **ENTER/→** and enter into test mode interface below:

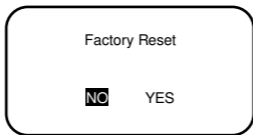

If changing the value, press **ENTER/→** to submit and the following message will prompt: Press **↑/+** or **↓/-** to select "save" to confirm update or cancel. After confirmed, the cursor will move back to the main menu.

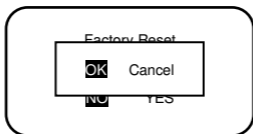

When updating successfully, the prompt will show below and then move back to the main menu.

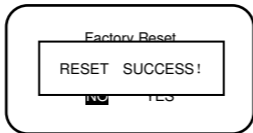

➤ **Reboot Device Setting Interface**

Press **MENU/←** or **ENTER/→** , move inverse cursor to **10. Reboot Device** , then press **ENTER/→** and enter into test mode interface below:

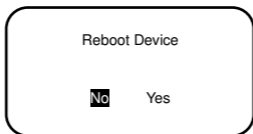

If needing to reboot the device, press **ENTER/→** to submit and the device will reboot at once.

5 Protection, Troubleshooting and Maintenance

5.1 Protection

• PV Array Short Circuit

If PV array short circuit occurs, clear it to resume normal charge automatically.

• Load Overload

If the load current exceeds the rated current of controller (≥ 1.05 times rated discharge current), the controller will disconnect the load. Overloading must be cleared up, then pressing the switch button.

• Load Short Circuit

Fully protected against load wiring short-circuit (≥ 2 times rated discharge current). After five automatic load reconnect attempt, the fault must be cleared by restarting the controller or pressing the switch button.

• PV Reverse Polarity

Fully protection against PV reverse polarity, no damage to the controller will result. Correct the miswire to resume normal operation.

• Battery Reverse Polarity

Fully protection against battery reverse polarity, no damage to the controller will result. Correct the miswire to resume normal operation.

• Battery working voltage error

If battery voltage does not match controller working voltage, controller will stop working. After correcting the voltage, the failure can be eliminated through pushing load button.

• Damaged Temperature Sensor

If the temperature sensor short-circuited or damaged, the controller will be charging or discharging at the default temperature 25°C to prevent the battery damaged from overcharging or over discharged.

• Overheating Protection

If the temperature of the controller heat sink exceeds 85°C , the controller will automatically start the overheating protection and stop the charging and discharging. When the temperature is below 75°C , the controller will resume to work.

• High Voltage Transients

PV is protected against smaller high voltage surge. In lightning prone areas, additional external suppression is recommended.

Note: The controller has daily automatic fault recovery function which will reduce the manual operation and can intelligently eliminate the fault caused by non-actual hardware failure.

5.2 Troubleshooting

Trouble Shooting

Table 5-1

Faults	Possible reasons	Troubleshooting
Charging LED indicator is off during daytime and the monitor shows Disconnect.	PV array disconnection	Check that PV and battery wire connections are correct and tight.
monitor shows Measure Err、MOS-I Short、MOS-C Short、MOS Break.	MOS-I or MOS-C are damaged.	Please restart controller; if the fault still exists, switch off controller immediately and contact the supplier to make maintenance.
Loads do not work and monitor shows LVD.	Battery is over discharged	The controller cut off the output automatically and recover when fully charged.
Charging and discharging circuit is off and monitor shows OVD.	Battery is over voltage	switch off the wiring of solar array and measure the voltage of battery whether is too high.
Charging and discharging circuit is off and the BATT of monitoring interface shows Over Temp.	Operating ambient temperature(local temperature sensor) or battery temperature(remot e temperature sensor) over temperature	When operating ambient temperature or battery temperature reaches exceeds 65°C controller will cut off input and output circuit automatically. When the temperature is below 55°C, controller will automatically reconnect input and output circuit.

<p>Charging and discharging circuit is off and monitor shows Error.</p>	<p>Battery voltage sensor is abnormal</p>	<p>Please restart controller, if the fault still exists, cut off charging and discharging circuit immediately and contact the supplier to make maintenance.</p>
<p>Discharging circuit is off and monitor shows Over Load.</p>	<p>Load power surpasses nominal power</p>	<p>Please reduce the number of electric equipments. When load power reaches 1.05-1.25 times, 1.25-1.5 times and 1.5 times more than nominal value, controller will automatically close loads in 60 seconds, 5 seconds and 1 second, respectively. It is reactivated after delayed 5 seconds for the first time, 10 seconds for the second time, 15 seconds for the third time, 20 seconds for the fourth time and 25 seconds for the fifth time. If over 5 times, push the key ENTER and controller recover output after 10 seconds. In the process of 5-time reactivation, if it is recovered manually, the 5-time reactivation will be circulated again. When there is any change from night to daytime, restart the self-recovery process. Namely, 5-time circular reactivation can be operated again.</p>

<p>Discharging circuit is off and the LOAD monitor shows Short.</p>	<p>Load circuit is short</p>	<p>Please check carefully loads connection; It is reactivated after delayed 5 seconds for the first time, 10 seconds for the second time, 15 seconds for the third time, 20 seconds for the fourth time and 25 seconds for the fifth time. If over 5 times, push the ENTER key and controller recover output after 10 seconds. In the process of 5-time reactivation, if it is recovered manually, the 5-time reactivation will be circulated again. When there is any change from night to daytime, restart the self-recovery process. Namely, 5-time circular reactivation can be operated again.</p>
<p>Charging and discharging circuit is off and the LOAD of monitoring interface shows MOS-I Short、Error.</p>	<p>Electronical component damaged.</p>	<p>Please restart controller, if the fault still exists, cut off charging and discharging circuit immediately and contact the supplier to make maintenance.</p>
<p>Charging and discharging circuit is off and the LOAD monitor shows Over Temp.</p>	<p>controller is over temperature</p>	<p>When the temperature of controller exceeds 85°C, the controller will cut input and output circuit. when it is below 75°C,the controller will automatically reconnect input and output circuit.</p>

5.3 Maintenance

The following inspections and maintenance tasks are recommended at least two times per year for best performance.

- Check that the air flow and ventilation around the controller is not blocked. Clear all dirt or fragments on the heat sink.
- Check all the naked wires to make sure insulation is not damaged for serious solarization, frictional wear, dryness, insects or rats etc. Maintain or replace the wires if necessary.
- Check and confirm that LED or LCD is consistent with required. Pay attention to any troubleshooting or error indication .Take corrective action if necessary.
- Tighten all the terminals. Inspect for loose, broken, or burnt wire connections.
- Confirm that all the terminals have no corrosion, insulation damaged, high temperature or burnt/discolored sign, tighten terminal screws to the suggested torque.
- Inspect for dirt, insects and corrosion, and clear up.
- Check and confirm that lightning arrester is in good condition. Replace a new one in time to avoid damaging of the controller and even other equipments.



NOTE: Dangerous with electric shock!

Make sure that all power source of controller is cut off when operate above processes, make inspection or other operations!

6 Technical specifications

Model:	1024	2024	3024	6024
VS****BN				

Electrical Parameters

Nominal System Voltage		12/24VDC Auto		
Maximum Battery Voltage		32V		
Maximum PV Voltage		48V		
Rated Charge Current	10A	20A	30A	60A
Rated Discharge Current	10A	20A	30A	60A
Charge Circuit Voltage Drop		≤0.69V		
Discharge Circuit Voltage Drop		≤0.17V		
Self-consumption		≤15mA@12v; ≤13mA@24v;		
Communication		RS485 / RJ45 interface		
Remote temperature sensor interface		2ERJ—3.81		
Ground		Negative to the ground		

Environmental parameters

LCD temperature		-20°C ~ +70°C		
Working temperature		-25°C ~ +55°C		
Humidity range		≤95%(N.C.)		
Enclosure		IP30		

Mechanical parameters

Terminal (mm ²)	4	10	16	35
Net weight (kg)	0.3	0.4	0.7	1.3

Model:	4548	6048
VS****BN		

Electrical Parameters

Nominal System Voltage	12/24/36/48VDC Auto	
Maximum Battery Voltage	64V	
Maximum PV Voltage	96V	
Rated Charge Current	45A	60A
Rated Discharge Current	45A	60A
Charge Circuit Voltage Drop	0.53V	
Discharge Circuit Voltage Drop	0.16V	
Self-consumption	$\leq 15\text{mA}@12\text{v};$ $\leq 10\text{mA}@24\text{v};$ $\leq 9\text{mA}@36\text{v};$ $\leq 8\text{mA}@48\text{v};$	
Communication	RS485 / RJ45 interface	
Remote temperature sensor interface	2ERJ—3.81	
Ground	Negative to the ground	

Environmental parameters

LCD temperature	20°C ~ +70°C	
Working temperature	25°C ~ +55°C	
Humidity range	95%(N.C.)	
Enclosure	IP30	

Mechanical parameters

Terminal (mm ²)	35	35
Net weight (kg)	1.2	1.6

Battery Control Parameters

All the coefficient is referred to 25℃, and twice in 24v system rate, triple in 36v system rate and quadruple in 48v system rate.

Battery Type	Sealed	Gel	Flooded	User
High Volt Disconnect	16V	16V	16V	9~17V
Charging limit voltage	15V	15V	15V	9~17V
Over Voltage Reconnect	15V	15V	15V	9~17V
Equalization voltage	14.6V	—	14.8V	9~17V
Boost voltage	14.4V	14.2V	14.6V	9~17V
Float voltage	13.8V	13.8V	13.8V	9~17V
Boost return voltage	13.2V	13.2V	13.2V	9~17V
Low voltage reconnect	12.6V	12.6V	12.6V	9~17V
Under voltage recover	12.2V	12.2V	12.2V	9~17V
Under voltage warning	12V	12V	12V	9~17V
Low voltage disconnect	11.1V	11.1V	11.1V	9~17V
Discharging limits voltage	10.6V	10.6V	10.6V	9~17V
Equalize duration	120min	—	120min	0~180min
Boost duration	120min	120min	120min	10~180min

Note: 1. When the battery type is sealed, gel, flooded, the adjusting range of equalize duration is 0 to180min and boost duration is 10 to180min.

2.The following rules must be observed when modify the parameters value in user battery type(factory default value is the same as sealed type):

Rule 1: High Volt Disconnect > Charging limit voltage \geq Equalization voltage \geq Boost voltage \geq Float voltage > Boost return voltage;

Rule 2: High Volt Disconnect > Over Voltage Reconnect;

Rule 3: Low voltage reconnect > Low voltage disconnect \geq Charging limit voltage

Rule 4: Under voltage recover > Under voltage warning \geq Charging limit voltage;

Rule 5: Boost return voltage > Low voltage reconnect

Threshold voltage value

Night Time Threshold Voltage	Upper limit	10V;20V / 24V; 30V / 36V; 40V / 48V
	Low limit	1V; 2V / 24V; 3V / 36V;4V / 48V
	Default	6V/12V
Day Time Threshold Voltage	Upper limit	10V; 20V / 24V;30V / 36V; 40V / 48V
	Low limit	1V; 2V / 24V; 3V / 36V;4V / 48V
	Default	5V/12V

Temperature compensate

Temperature compensate coefficient	Upper limit	0mV / °C / 2V
	Low limit	-9mV / °C / 2V
	Default	-3mV / °C / 2V @25°C

* Compensation of equalize, boost, float and low voltage disconnect voltage.

SOC parameters

Precent of charging	100% constant value
Precent of discharging	10~80%, Low SOC reconnect is higher Low SOC disconnect than 5%

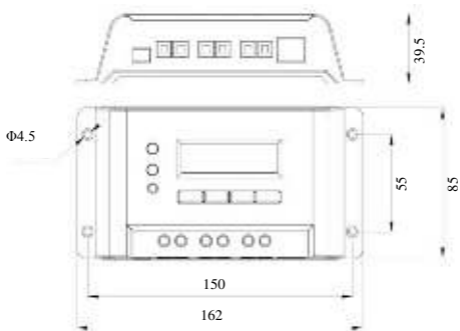

VS1024BN Dimensions in Millimeters [Inches]

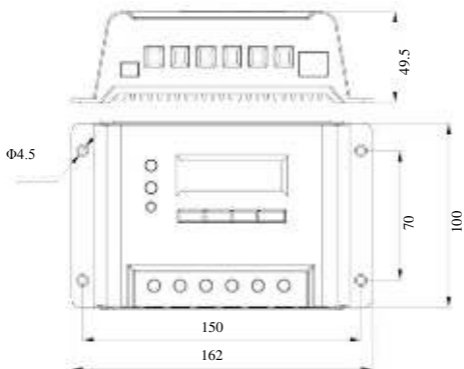

VS2024BN Dimensions in Millimeters [Inches]

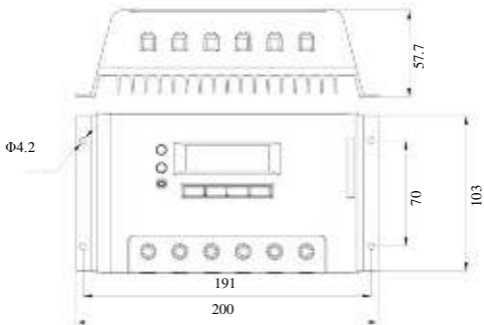

VS3024BN Dimensions in Millimeters [Inches]

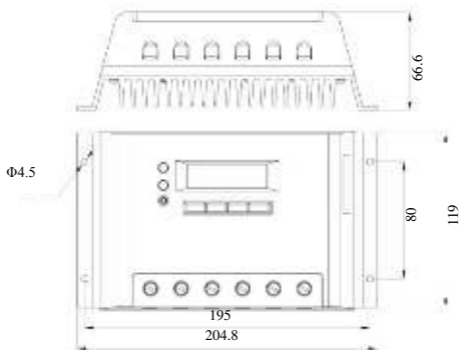

VS4548BN Dimensions in Millimeters [Inches]

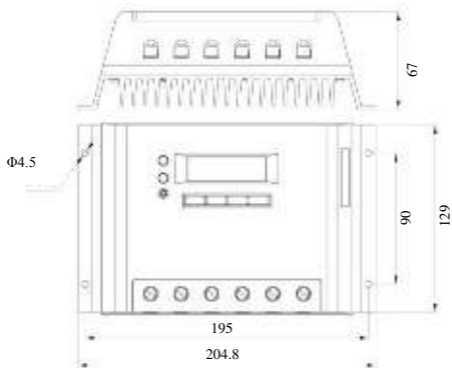

VS6024BN Dimensions in Millimeters [Inches]

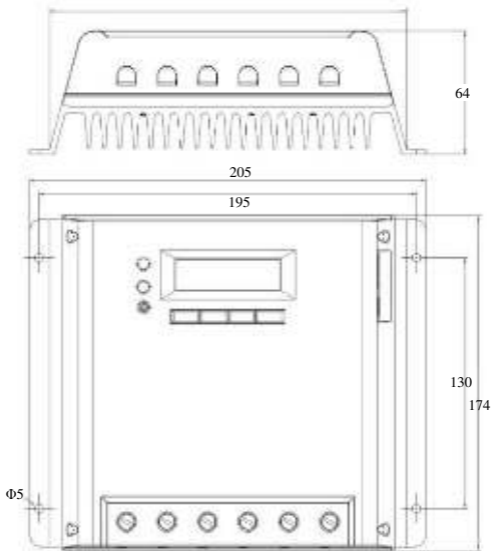

VS6048BN Dimensions in Millimeters [Inches]

Any changes without prior notice! Version number: V2.0



HUIZHOU EPEVER TECHNOLOGY CO., LTD.

Beijing Tel: +86-10-82894112/82894962

Huizhou Tel: +86-752-3889706

E-mail: info@epsolarpv.com

Website: www.epsolarpv.com

www.epever.com